

Article number: 4320001201

Description: Rota-fix shaft-hub connection A 120x165  
Stainless Steel

## Measures

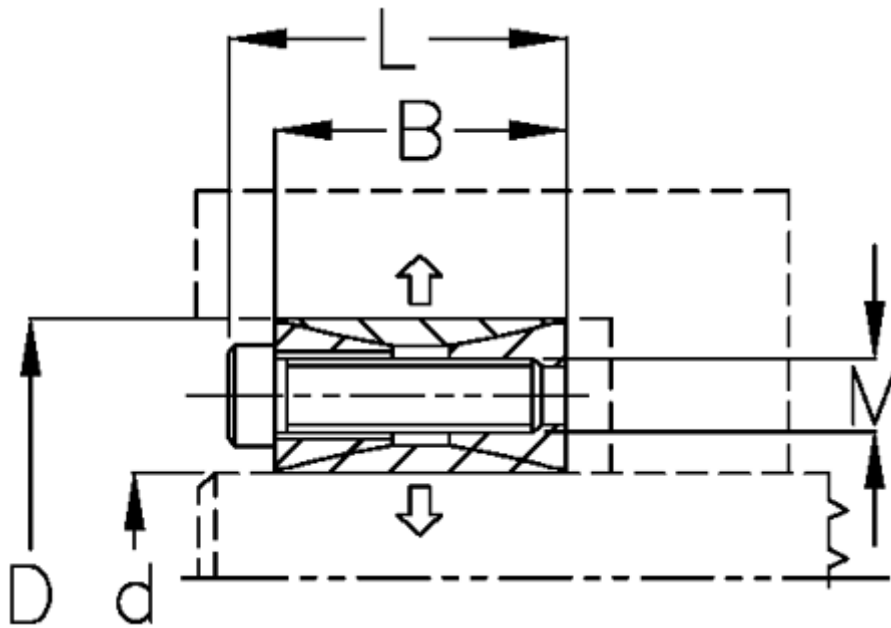

B mm	= 33
d H8 mm	= 120
D mm	= 165
Fit tolerance	= Aksel k11-h11, Nav N11-H11
F kN torque	= 132.0
L mm	= 45
M mm	= M12
P N/mm <sup>2</sup> surface pressure on shaft/hub	= 51

Surface roughness	=
T N m torque	=
Ts N m bolt tightening torque	=